

# PERGOLA TOP HORIZON III

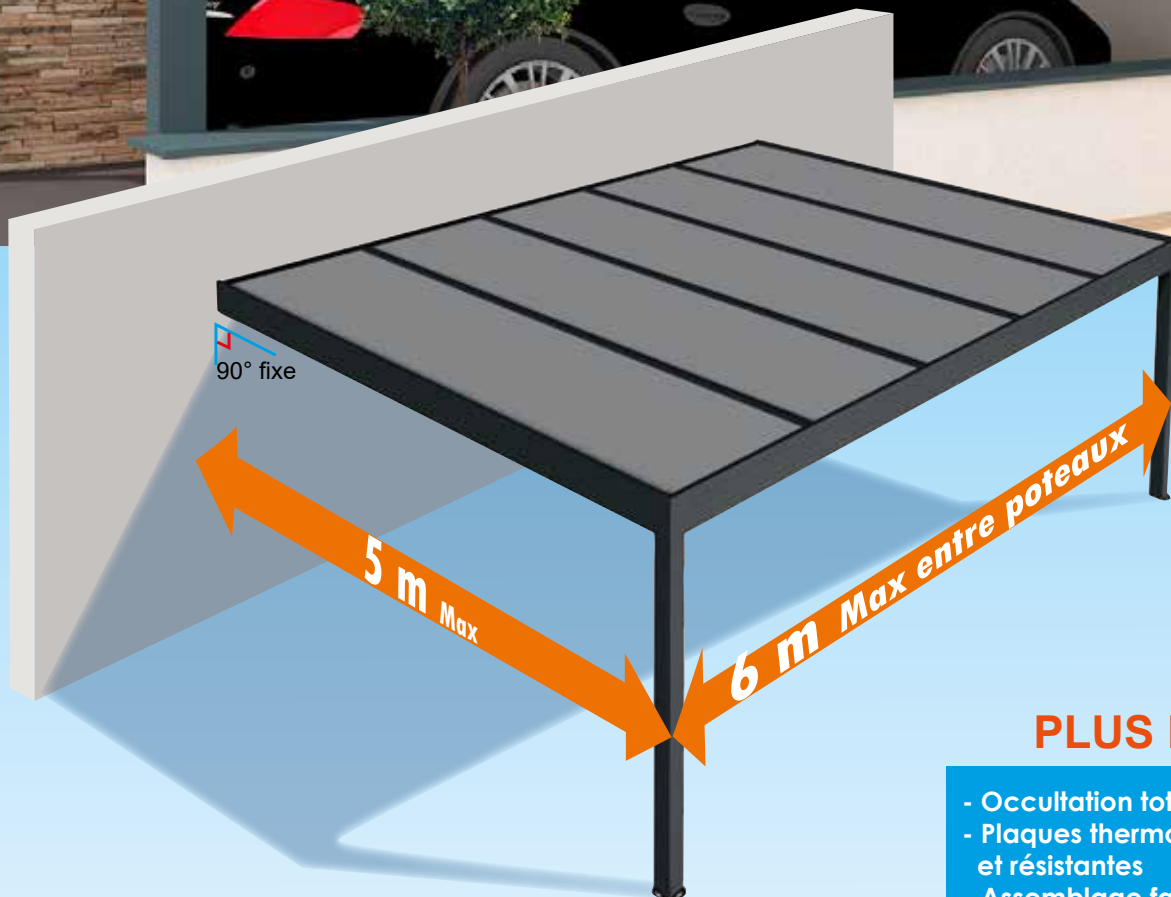

## PRODUCT ADVANTAGES:

- Total and constant coverage
- 32mm Thermotop lightweight and durable
- Easy assembly with clip-on system
- Board width up to 1.20m
- Multi-purpose coverage: driveway, garden, terrace
- Water drainage thanks to its posts
- Option to move posts up to 1 m
- 115 x 115 Post

## PLUS PRODUIT :

- Occultation totale et constante
- Plaques thermotop légères et résistantes
- Assemblage facile avec système à clipper
- Largeur plaque jusqu'à 1,20 mètre
- Abri multi-usages : abri de voiture, terrasse et jardin
- Evacuation de l'eau grâce aux poutres
- Pieds déportés jusqu'à 1 mètre
- Poteaux de 115 x 115



**FERMETURE-ONLINE**

Portails - Fenêtres - Volets - Pergolas - Portes

# TOP HORIZON III



Disponible  
en version îlot (4 pieds)  
Free standing model  
available ( 4 posts )

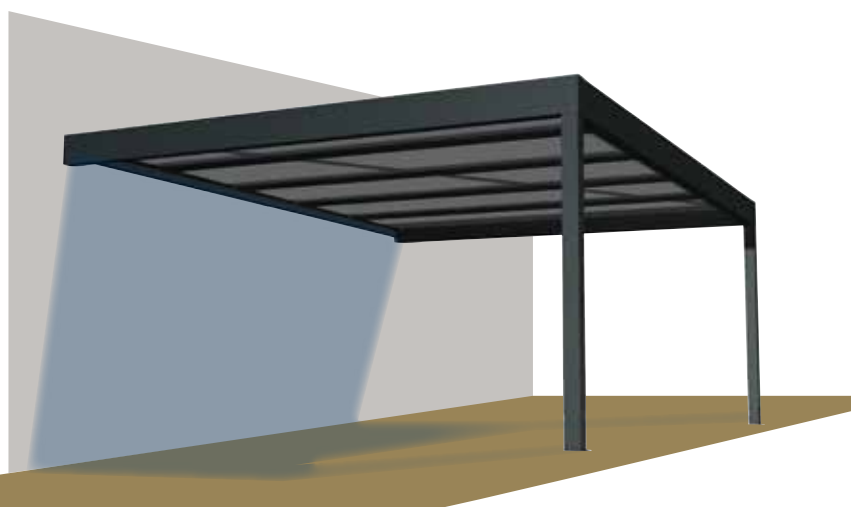
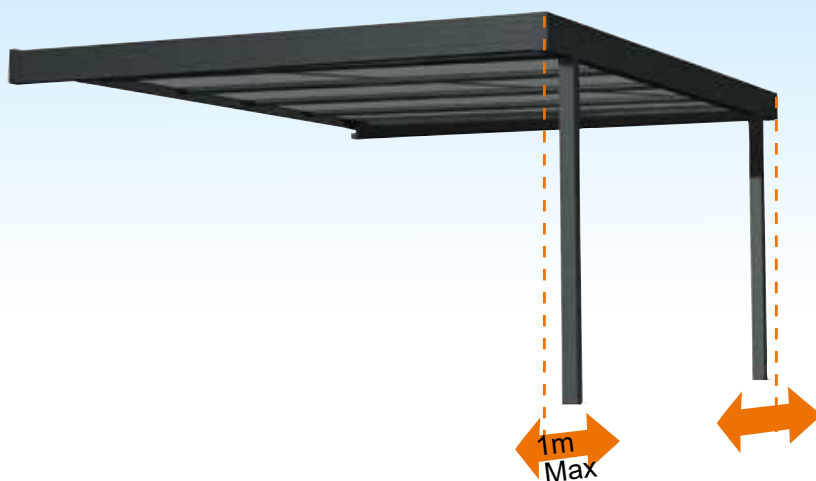

## DIMENSIONS MAXI D'UTILISATION

Largeur par plaque : 1,20 mètre **Maxi**  
Largeur entre les poteaux : 6,00 mètres  
Avancée maxi : 5,00 mètres  
Hauteur max des poteaux îlot: 2,50 m  
Hauteur max en pose adossée: 3,00 m  
Inclinaison fixe 0°  
Pente des panneaux 5 cm

## MAX DIMENSIONS:

Board width: 1.20 meters  
Width between posts: 6.00 meters  
Maximum projection: 5.00 meters  
Standard post height: 2.50 meters  
Fixed tilt: 0°  
Slope of the panels 5 cm

# INFORMATION TECHNIQUE / TECHNICAL INFORMATION

La pergola TOP Horizon III est compatible avec tous les panneaux sandwich d'épaisseur 32mm, afin d'ajuster au mieux l'ensoleillement de votre terrasse en fonction de vos besoins.

New TOP Horizon III Pergola is compatible with all 32mm thick boards, either Thermotopor, for a better adjustment of the sunlight on your terrace according to your needs.

Panneaux (Thermotop) disponibles en :  
Thermotop boards are available in:



- blanc & blanc (sur les 2 faces)

- White / White ( Two sides )



- Anthracite & blanc (à l'intérieur)  
(4m max d'avancée)

- Anthracite and White ( Inside )  
(maximum projection)

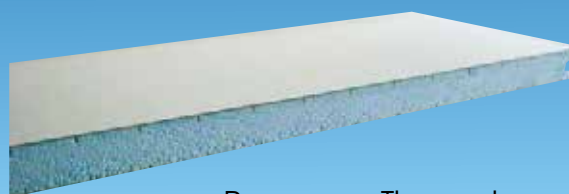

Panneaux Thermotop  
Thermotop boards

## Clipper les profils de verrouillage des plaques. Easy board clip-on system

Easy board clip-on system

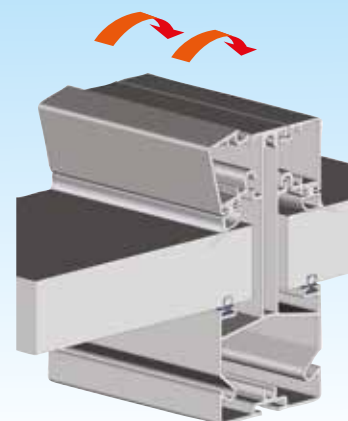
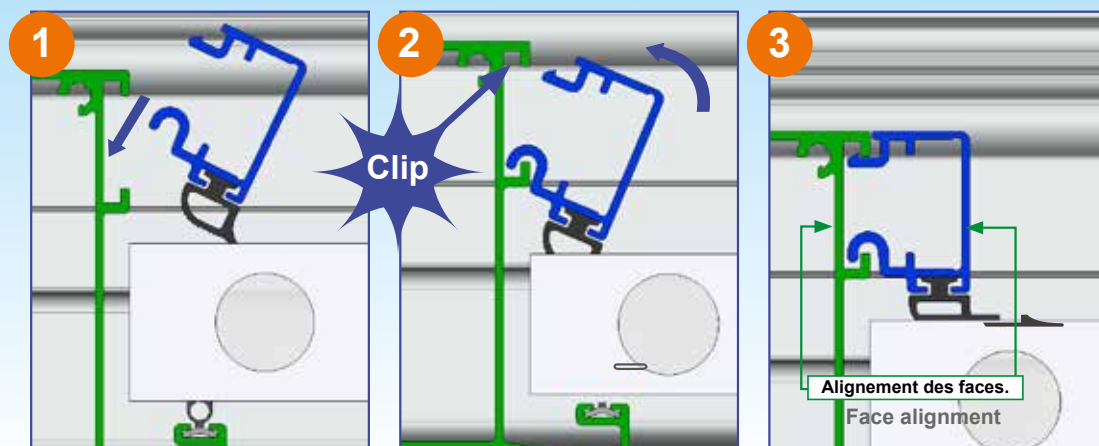

## Evacuation de l'eau (drainage) Water drainage

Water drainage





# OPTIONS - ACCESSOIRES



## Finition standard de la structure Standard frame finishing:



**RAL 7016 ANTHRACITE**  
Laquage téflonné  
RAL 7016 Textured powder  
coat( anthracite )

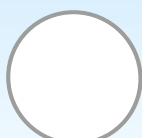

**RAL 9010 blanc**  
Laquage brillant  
RAL9010 - Glossy white  
powder coat

## Option éclairage LED Led lighting option:

- Nombre de ruban LED modulable (1 bandeau, 3 côtés au total)
- Commande à télécommande centralisée des LED
- Adjustable LED string (1 strip, 3 sidestotal)
- Operated by centralised remote control



## Habillage latéral Side coverage



Habillage avec stores  
screen coulissants  
Side coverage with sliding  
screens

## Fixation au sol Floor fixation

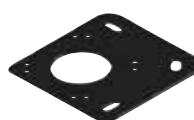

Support de fixation au sol : **ST4502**  
Floor fixation support: **ST4502**

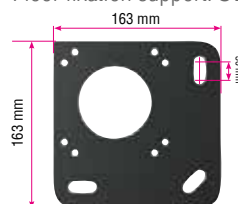

Support de fixation au sol **ST45**  
Floor fixation support: **ST45**

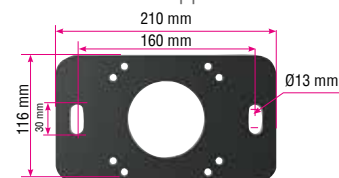

**FERMETURE-ONLINE**  
Portails - Fenêtres - Volets - Pergolas - Portes